

PST KK270

HIGH POWER FAST SWITCHING THYRISTOR FOR INVERTER AND CHOPPER APPLICATIONS

Features :

- Blocking Capability up to 800 V
- High dV/dt Capability
- All Diffused Structure
- Amplifying Gate Configuration
- Rugged Ceramic Hermetic Package

ELECTRICAL CHARACTERISTICS AND RATINGS

Blocking

Parameter	Symbol	Min	Max	Typ	Unit	Conditions
Repetitive peak reverse voltage	V_{RRM}		800		V	$T_j = -40\text{ °C to }125\text{ °C}$
Repetitive peak off-state voltage	V_{DRM}		800		V	$T_j = -40\text{ °C to }125\text{ °C}$
Non repetitive peak reverse voltage	V_{RSM}		900		V	$T_j = -40\text{ °C to }125\text{ °C}$
Repetitive peak reverse current	I_{RRM}		70		mA	$T_j = T_{jmax}, V = V_{RRM}$
Repetitive peak off-state current	I_{DRM}		70		mA	$T_j = T_{jmax}, V = V_{DRM}$

Conducting

Parameter	Symbol	Min	Max	Typ	Unit	Conditions
Average value of on-state current	$I_{T(AV)}$		900		A	50 Hz sine wave, 180° conduction, $T_c = 85\text{ °C}$
RMS value of on-state current	$I_{T(RMS)}$		1400		A	50 Hz sine wave, 180° conduction, $T_c = 85\text{ °C}$
Surge non repetitive current	I_{TSM}		12		kA	50 Hz sine wave Half cycle
I square t	$I^2 t$		720		kA^2s	$V_R = 0$ $T_j = T_{jmax}$
Peak on-state voltage	V_{TM}		1.8		V	On-state current 1400 A, $T_j = T_{jmax}$
Threshold voltage	$V_{T(TO)}$		1.35		V	$T_j = T_{jmax}$
On-state slope resistance	r_T		0.350		$m\Omega$	$T_j = T_{jmax}$
Holding current	I_H			300	mA	$V_D = 12\text{ V}; I_T = 2.5\text{ A}$
Latching current	I_L			700	mA	$V_D = 12\text{ V}; R_L = 12\ \Omega$

PST KK270

HIGH POWER FAST SWITCHING THYRISTOR

Triggering

Parameter	Symbol	Min	Max	Typ	Unit	Conditions
Gate current	I_{GT}		400		mA	$V_D = 6\text{ V}, R_L = 3\ \Omega, T_j = -40\ ^\circ\text{C}$
			300		mA	$V_D = 6\text{ V}, R_L = 3\ \Omega, T_j = 25\ ^\circ\text{C}$
			150		mA	$V_D = 6\text{ V}, R_L = 3\ \Omega, T_j = 125\ ^\circ\text{C}$
Gate voltage	V_{GT}		5		V	$V_D = 6\text{ V}, R_L = 3\ \Omega, T_j = -40\ ^\circ\text{C}$
			3		V	$V_D = 6\text{ V}, R_L = 3\ \Omega, T_j = 0 \div 125\ ^\circ\text{C}$
		0.25			V	$V_D = V_{DRM}, R_L = 1\ \text{k}\Omega, T_j = 125\ ^\circ\text{C}$
Peak gate current	I_{GM}		10		A	
Peak reverse gate voltage	V_{RGM}		5		V	
Peak gate power dissipation	P_{GM}		200		W	
Average gate power dissipation	$P_{G(AV)}$		5		W	

Switching

Parameter	Symbol	Min	Max	Typ	Unit	Conditions
Critical rate of rise of on-state current - non repetitive	di/dt		1500		A/ μs	$I_G = 5 \cdot I_{GT}, t_r = 1\ \mu\text{s}, V_{DRM} \leq 1000\text{V}, T_j = T_{jmax}$
Critical rate of rise of on-state voltage	dv/dt		600		V/ μs	Linear ramp up to 80% of V_{DRM}
Gate controlled delay time	t_d		1.5	0.5	μs	$I_{TM} = 500\text{ A}, V_D = V_{DRM}, V_G = 20\text{ V}$ $R_G = 20\ \Omega, t_r = 0.1\ \mu\text{s}, t_p = 20\ \mu\text{s}$
Turn-off time	t_q	10			μs	$I_{TM} = 1000\text{ A}; di/dt = 50\text{ A}/\mu\text{s}; V_R \geq 50\text{ V}$ $dV/dt = 200\text{ V}/\mu\text{s}$ linear to 80% V_{DRM} $V_G = 0\text{ V}; T_j = 125\ ^\circ\text{C}$
Reverse recovery charge	Q_{rr}		*	40	μC	$I_T = 1000\text{ A}$ $di/dt = 60\text{ A}/\mu\text{s}$
Reverse recovery current	I_{rr}		*	100	A	$V_R \geq 50\text{ V}$ $T_j = T_{jmax}$

* for guaranteed max value, please contact Factory

Thermal and mechanical

Parameter	Symbol	Min	Max	Typ	Unit	Conditions
Operating temperature	T_j	-40	125		$^\circ\text{C}$	
Storage temperature	T_{stg}	-40	125		$^\circ\text{C}$	
Thermal resistance junction to case	$R_{th(j-c)}$		0.021		$^\circ\text{C}/\text{W}$	Double side cooled , 180° SIN
Thermal resistance case to sink	$R_{th(c-s)}$		0.011		$^\circ\text{C}/\text{W}$	Double side cooled, mounting surfaces smooth, flat and greased
Mounting force	F	10	14		kN	
Weight	W			250	g	

PST KK270

HIGH POWER FAST SWITCHING THYRISTOR

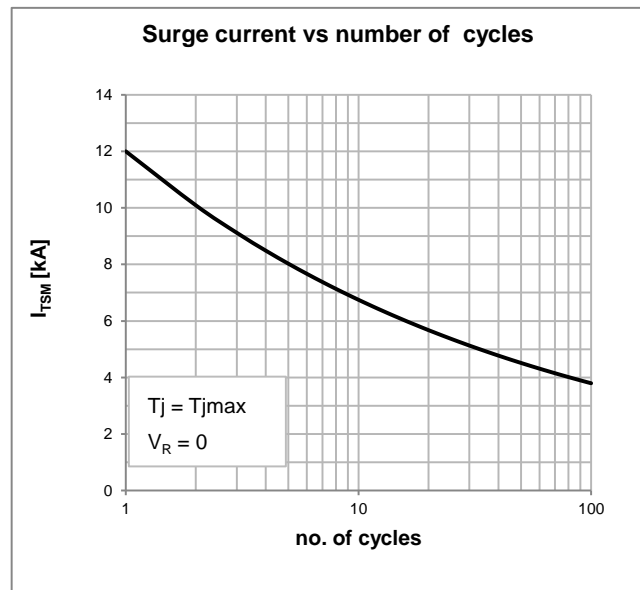
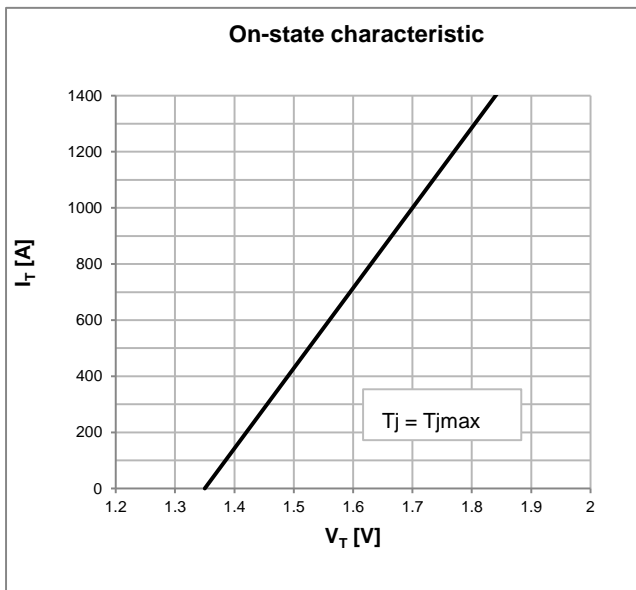
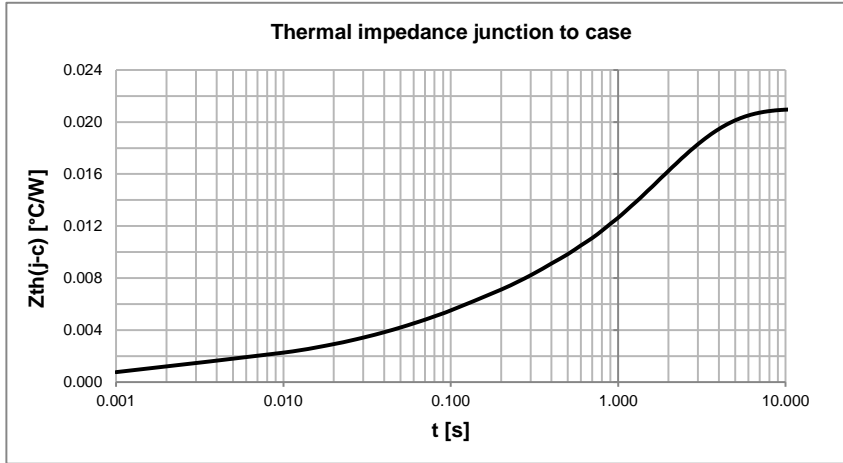

OUTLINE AND DIMENSIONS

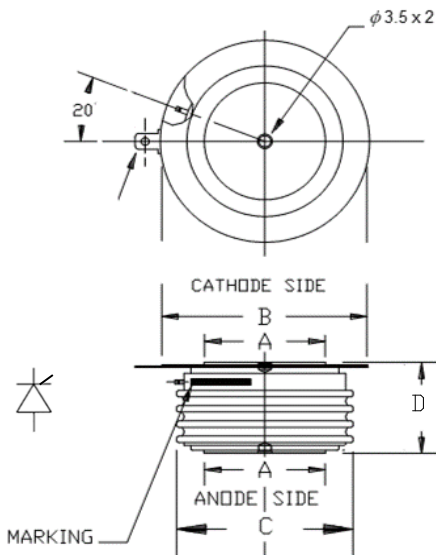

	A	B	C	D
mm	34	56 - 64	55	26 ± 1

- All the characteristics given in this data sheet are guaranteed only with uniform clamping force, cleaned and lubricated heatsink surfaces with flatness < 0.03 mm and roughness < 2µm